

PTR8000+

Low Power UHF Wireless Transceiver Module

Features:

- 433MHz ISM Band
- Power supply range:1.9~3.6 V
- Half Duplex
- 100kbps data rate
- Digital interface (SPI) speed :0~10Mbps
- Maximum output power +10dBm
- Channel Switching time <650us
- Data Ready signal(DR) when a valid data packet is received or transmitted
- Carrier detect for "listen before transmit"
- Address Match for detection of incoming packet
- Automatic retransmission of data packet
- Automatic CRC and preamble generation
- PTR8000 with Loop PCB antenna (Size about 42x37mm)
- PTR8000+ with SMA Whip Antenna (Size about 43x35mm)
- PTR8000 about 100 meters in open space, PTR8000+ about 200-300 meters in open space
- 100% RF tested
- Power down current 2.5uA

Typical Applications:

- Security Applications
- Vehicle alarm systems
- Remote meter reading
- Remote data acquisition
- Alarm and Security System
- Authorization / Access control
- Automatic Meter Reading (AMR)
- High integrity wireless Fire / Security alarms
- Building environment control / monitoring
- Wireless mouse/keyboard and PC peripherals
- Wireless hands free
- Sports and leisure equipment
- Game pads
- Wireless Communication

Performance Data:

Parameter	Value	Unit
Supply voltage	1.9~3.6	V
Maximum transmit output power	10	dBm
Data rate	100	kbps
Supply current in transmit @ -10dBm output power	11	mA
Supply current in receive mode	12.5	mA
Typical Sensitivity	-100	dBm
Supply current in power down mode	2.5	uA

Pin assignment (top view)

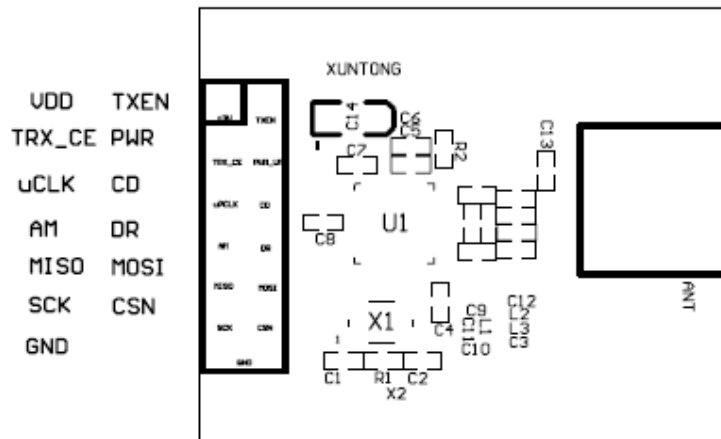

Pin	Function	Direction	Remark
Pin1	VCC	I	Power Supply (1.9~3.6V DC)
Pin2	TXEN	I	TX_EN="1"TX mode, TX_EN="0"RX mode
Pin3	TRX_CE	I	Enables chip for receive / transmit
Pin4	PWR	I	Power up chip/ Power down
Pin5	uCLK	O	Output clock, divided crystal oscillator full-swing clock
Pin6	CD	O	Carrier Detect output
Pin7	AM	O	Address Match output
Pin8	DR	O	Data Ready output
Pin9	MISO	O	SPI output
Pin10	MOSI	I	SPI input
Pin11	SCK	I	SPI clock
Pin12	CSN	I	SPI enable, active low
Pin13	GND		Ground (0V)
Pin14	GND		Ground (0V)

Hardware interface:

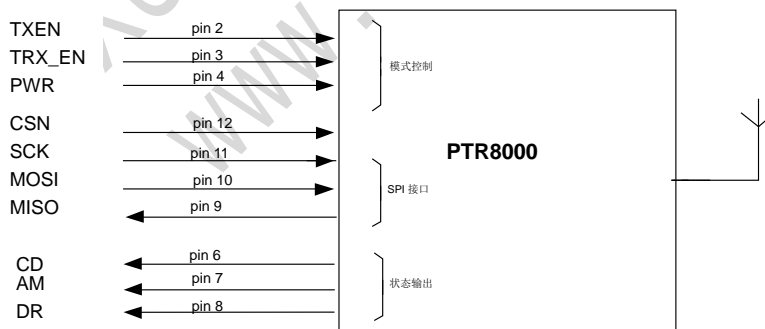

1、 Mode Control:

PTR8000 module can work in following modes depending on TRX_CE, TX_EN, and PWR:

PWR	TRX_CE	TX_EN	Operating mode
0	X	X	Power down and SPI programming mode
1	0	X	Standby and SPI programming mode
1	1	0	Receive mode
1	1	1	Transmit mode

Application Note:

1. SPI Interface:

SPI is composed of SCK, MISO, MOSI and CSN.

- (1) Under standby or power down mode, MCU set register's parameters though SPI
- (2) Under receive/transmit mode, MCU read out or write on data though SPI
- (3) The SPI interface is a standard SPI interface, maximum data rate is 10Mbps

2. Supply current in different modes

- (1) In standby mode, power consumption is about 40uA, transmit/receive circuit is turned off, and just SPI is working.
- (2) In power down mode, power consumption is about 2.5uA, all circuit modules are turned off, it is the most consumption saving mode.
- (3) In standby and power down mode, PTR8000+ cannot transmit and receive, but you can configure it.

SPI Instruction

SPI Instruction Set		
Instruction Name	Instruction Format	Operation
W_CONFIG (WC)	0000AAAA	Write Configuration-register. AAAA indicates which byte the write operation is to be started from. Number of bytes depends on start address AAAA.
R_CONFIG (RC)	0001AAAA	Read Configuration-register. AAAA indicates which byte the Read operation is to be started from. Number of bytes depends on start address AAAA.
W_TX_PAYLOAD (WTP)	00100000	Write TX-payload: 1 – 32 bytes. A write operation will always start at byte 0.
R_TX_PAYLOAD (RTP)	00100001	Read TX-payload: 1 – 32 bytes. A read operation will always start at byte 0.
W_TX_ADDRESS (WTA)	00100010	Write TX-address: 1 – 4bytes. A write operation will always start at byte 0.
R_TX_ADDRESS (RTA)	00100011	Read TX-address: 1 – 4bytes. A read operation will always start at byte 0.
R_RX_PAYLOAD (RRP)	00100100	Read RX-payload: 1 – 32 bytes. A read operation will always start at byte 0.
CHANNEL_CONFIG (CC)	1000pphc ccccccc	The content of the status-register (S[7:0]) will always be read to MISO after a high to low transition on CSN as shown in Figure 6 and 7.

SPI Timing

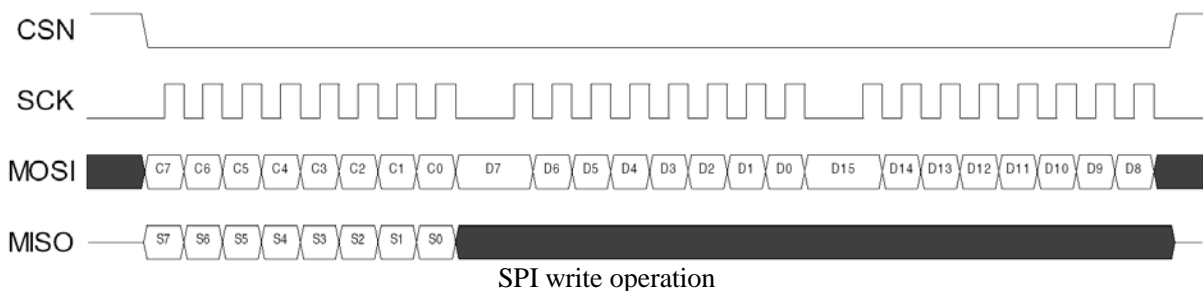
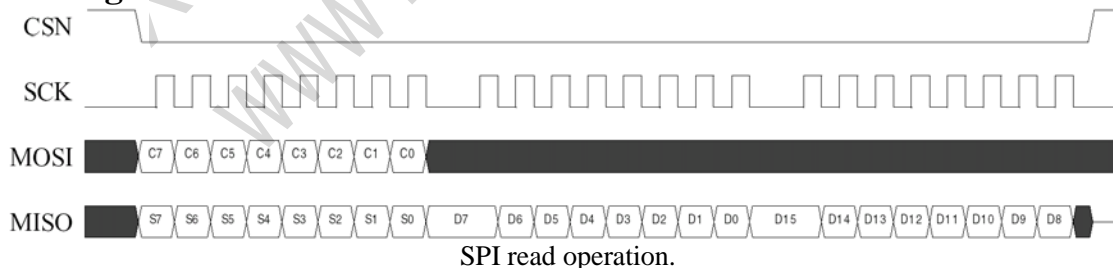

RF – Configuration Register Description

Parameter	Bit width	Description
CH_NO	9	Sets center freq. together with HFREQ_PLL (default = 001101100b = 108d). $f_{RF} = (422.4 + CH_NO_d / 10) * (1 + HFREQ_PLL_d)$ MHz
HFREQ_PLL	1	Sets PLL in 433 or 868/915 MHz mode (default = 0). '0' – Chip operating in 433MHz band '1' – Chip operating in 868 or 915 MHz band
PA_PWR	2	Output power (default = 00). '00' -10dBm '01' -2dBm '10' +6dBm '11' +10dBm
RX_RED_PWR	1	Reduces current in RX mode by 1.6mA. Sensitivity is reduced (default = 0). '0' – Normal operation '1' – Reduced power
AUTO_RETRAN	1	Retransmit contents in TX register if TRX_CE and TXEN are high (default = 0). '0' – No retransmission '1' – Retransmission of data packet
RX_AWF	3	RX-address width (default = 100). '001' – 1 byte RX address field width '100' – 4 byte RX address field width
TX_AWF	3	TX-address width (default = 100). '001' – 1 byte TX address field width '100' – 4 byte TX address field width
RX_PW	6	RX-payload width (default = 100000). '000001' – 1 byte RX payload field width '000010' – 2 byte RX payload field width '100000' – 32 byte RX payload field width
TX_PW	6	TX-payload width (default = 100000). '000001' – 1 byte TX payload field width '000010' – 2 byte TX payload field width '100000' – 32 byte TX payload field width
RX_ADDRESS	32	RX address identity. Used bytes depend on RX_AFW (default = E7E7E7E7h).
UP_CLK_FREQ	2	Output clock frequency (default = 11). '00' – 4MHz '01' – 2MHz '10' – 1MHz '11' – 500kHz
UP_CLK_EN	1	Output clock enable (default = 1). '0' – No external clock signal available '1' – External clock signal enabled
XOF	3	Crystal oscillator frequency. Must be set according to external crystal resonant frequency (default = 100). '011' – 16MHz
CRC_EN	1	CRC – check enable (default = 1). '0' – Disable '1' – Enable
CRC_MODE	1	CRC – mode (default = 1). '0' – 8 CRC check bit '1' – 16 CRC check bit

RF – Configuration Register Description

RF-CONFIG_REGISTER Contents

RF-Configuration-Register(R/W)		
Byte#	Content bit [7:0], MSB = bit [7]	Init value
0	CH_NO [7:0]	0110_1100
1	Bit [7:6] not used, AUTO_RETRAN, RX_RED_PWR, PA_PWR [1:0], HFREQ_PLL, CH_NO [8]	0000_0000
2	Bit [7] not used, TX_AFW [2:0], Bit [3] not used, RX_AFW [2:0]	0100_0100
3	Bit [7:6] not used, RX_PWR [5:0]	0010_0000
4	Bit [7:6] not used, TX_PWR [5:0]	0010_0000
5	RX_ADDRESS (device identity) byte 0	E7
6	RX_ADDRESS (device identity) byte 1	E7
7	RX_ADDRESS (device identity) byte 2	E7
8	RX_ADDRESS (device identity) byte 3	E7
9	CRC_MODE, CRC_EN, XOF [2:0], UP_CLK_EN, UP_CLK_FREQ [1:0]	1110_0111

TX_PAYLOAD(R/W)		
Byte#	Content bit [7:0], MSB = bit [7]	Init value
0	TX_PAYLOAD [7:0]	X
1	TX_PAYLOAD [15:8]	X
		X
		X
30	TX_PAYLOAD [247:240]	X
31	TX_PAYLOAD [255:248]	X

TX_ADDRESS(R/W)		
Byte#	Content bit [7:0], MSB = bit [7]	Init value
0	TX_ADDRESS [7:0]	E7
1	TX_ADDRESS [15:8]	E7
2	TX_ADDRESS [23:16]	E7
3	TX_ADDRESS [31:24]	E7

RX_PAYLOAD(R)		
Byte#	Content bit [7:0], MSB = bit [7]	Init value
0	RX_PAYLOAD [7:0]	X
1	RX_PAYLOAD [15:8]	X
		X
		X
30	RX_PAYLOAD [247:240]	X
31	RX_PAYLOAD [255:248]	X

STATUS_REGISTER(R)		
Byte#	Content bit [7:0], MSB = bit [7]	Init value
0	AM, bit [6] not used, DR, bit [4:0] not used	E7

Register content is not lost when the device enters one of the power saving modes.

Device Switching Times, PTR8000 in active mode must observe the following times

PTR8000 timing	Max.
PWR_DWN→ST_BY mode	3ms
STBY→TX ShockBurst™ mode	650us
STBY→RX ShockBurst™ mode	650us
RX ShockBurst™ mode →TX ShockBurst™ mode	550us
TX ShockBurst™ mode →RX ShockBurst™ mode	550us

Switching times for PTR8000

Notes: RX to TX or TX to RX switching is available without re-programming of the RF configuration register.
The same frequency channel is maintained.

Programming of PTR8000+

By placing all high speed signal processing related to RF protocol on-chip, PTR8000+ can connect with most kinds of cheap micro controller (MCU), and also can use high-speed processor as DSP etc. PTR8000 offers a simple SPI interface to application micro controller, which the data rate is decided by the micro controller. In ShockBurst™ RX mode, when a valid address and payload is received respectively, then Address Match (AM) and Data Ready (DR) notifies the MCU, and MCU can clock out the payload data at a suitable rate via the SPI interface. In ShockBurst™ TX mode, PTR8000 can auto-generates preamble and CRC, Data Ready (DR) notifies the MCU that the transmission is completed. All together, this means reduced memory demand in the MCU resulting in a low cost MCU, as well as reduced software development time.

(1) Configuration

After power on, first, MCU configure the PTR8000+ module .control PWR、TXEN、TRX_CE interface set module in Standby and SPI - programming mode,MCU clock the configure word into PTR8000+ via SPI interface, the configuration word content is maintained during standby and power down mode.

(2) ShockBurst™ TX mode

- 1) When the application MCU has data for a remote node, the address of the receiving node (TX-address) and payload data (TX-payload) are clocked into PTR8000+ via the SPI interface. The application protocol or MCU sets the speed of the interface.
- 2) MCU sets TRX_CE and TX_EN high, this activates PTR8000++ ShockBurst™ transmission.
- 3) PTR8000+ auto-processing:
 - Radio is automatically powered up.
 - Data packet is completed (add preamble and CRC calculation).
 - Data packet is transmitted (100kbps, GFSK, Manchester-encoded).
- 4) If AUTO_RETRAN is set high, the PTR8000+ continuously retransmits the packet until TRX_CE is set low.
- 5) When TRX_CE is set low, the PTR8000+ finishes transmitting and then sets itself into standby mode.

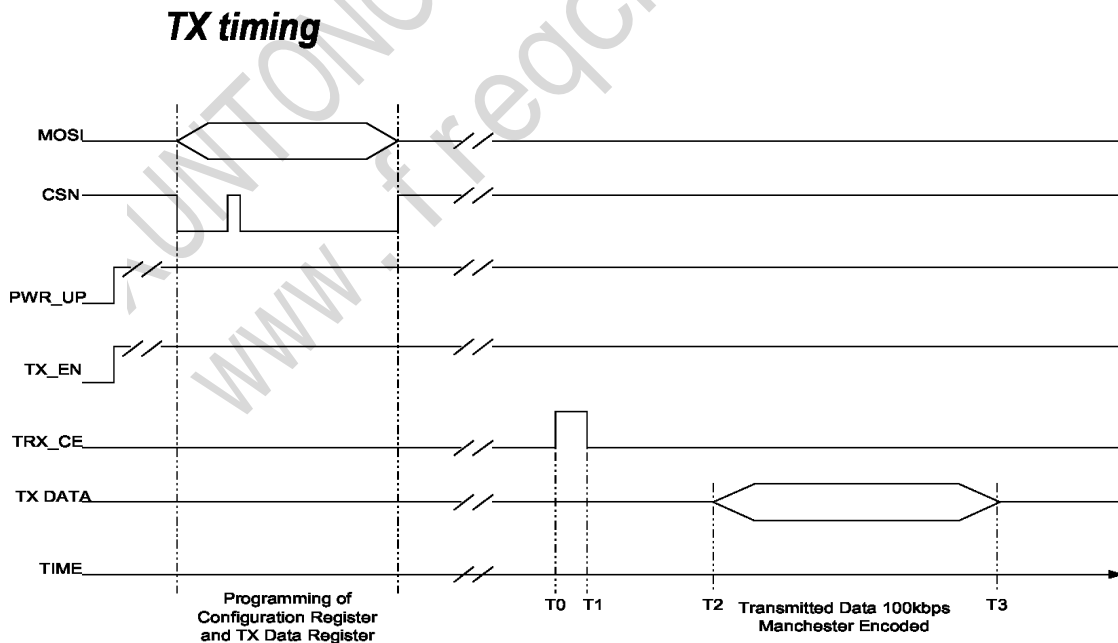

Timing diagram for transmitting

(3) ShockBurst™ RX mode

- 1) ShockBurst™ RX is selected by setting TRX_CE high and TX_EN low.
- 2) After 650us nRF905 is monitoring the air for incoming communication.
- 3) When the nRF905 senses a carrier at the receiving frequency, Carrier Detect (CD) pin is set high.
- 4) When a valid address is received, Address Match (AM) pin is set high.
- 5) When a valid packet has been received (correct CRC found), nRF905 removes the preamble, address and CRC bits, and the Data Ready (DR) pin is set high.
- 6) MCU sets the TRX_CE low to enter standby mode (low current mode).
- 7) MCU can clock out the payload data at a suitable rate via the SPI interface.
- 8) When all payload data is retrieved, nRF905 sets Data Ready (DR) and Address Match (AM) low again.
- 9) The chip is now ready for entering ShockBurst™ RX, ShockBurst™ TX or power down mode.

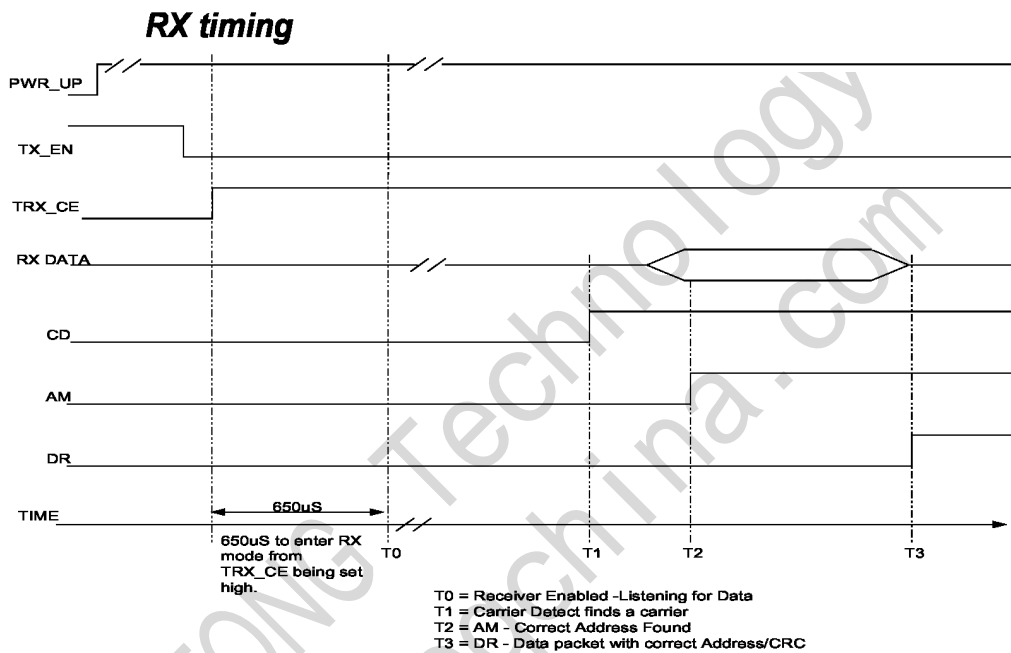

Timing diagram for receiving

Frequency Configure Example

RF frequency is set by CH_NO and HFREQ_PLL. The operating frequency is given as below:

$$f = (422.4 + CH_NO/10) * (1 + HFREQ_PLL) \text{MHz}$$

When HFREQ_PLL = '0' the frequency resolution is 100kHz and when it is '1' the resolution is 200kHz.

Freq.	HFREQ_PLL	CH_No
433.0MHZ	[0]	[001001100]
433.1MHZ	[0]	[001101011]
433.2MHZ	[0]	[001101100]
434.7MHZ	[0]	[001111011]
862.0MHZ	[1]	[001010110]
868.2MHZ	[1]	[001110101]
868.4MHZ	[1]	[001110110]
869.8MHZ	[1]	[001111101]
902.2MHZ	[1]	[100011111]
902.4MHZ	[1]	[100100000]
927.8MHZ	[1]	[110011111]

PTR8000+ hardware interface to MCU

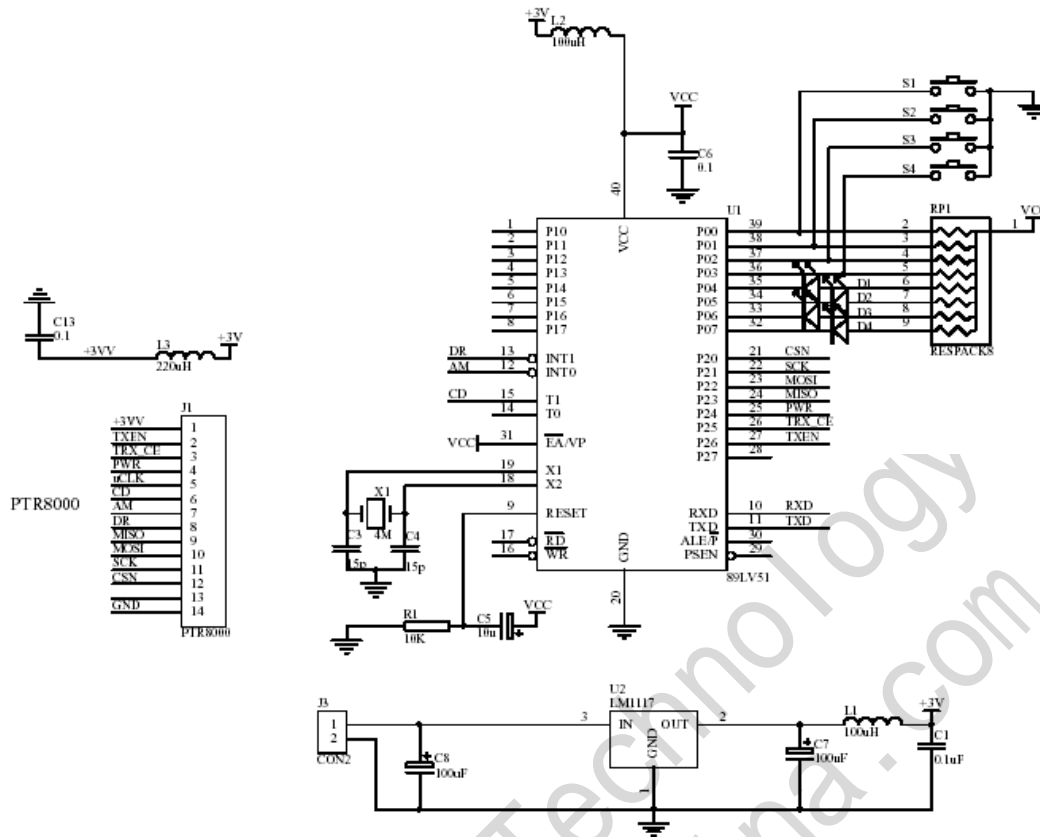

- 1) SPI interface can realized through MCU I/O port software simulating and also can connected with any other MCU SPI interface.
- 2) CD, AM, DR can be connected to MCU interrupt or I/O port
- 3) PTR8000+ can be connected to any low speed and high-speed processor.
- 4) MCU supply voltage and logic voltage should be 3V,if PTR8000+ connect to MCU of 5V voltage, voltage transition or voltage divide is compulsory.

Application

1): Point-to-point wireless communication

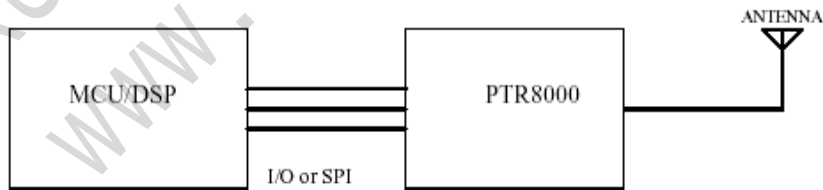

2): Point to multi-point data transmitting in data acquisition system

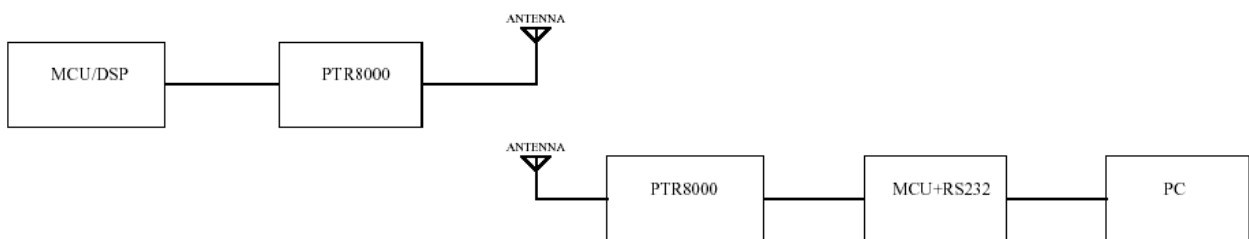

3): Point to multi-points bi-directional data transmission

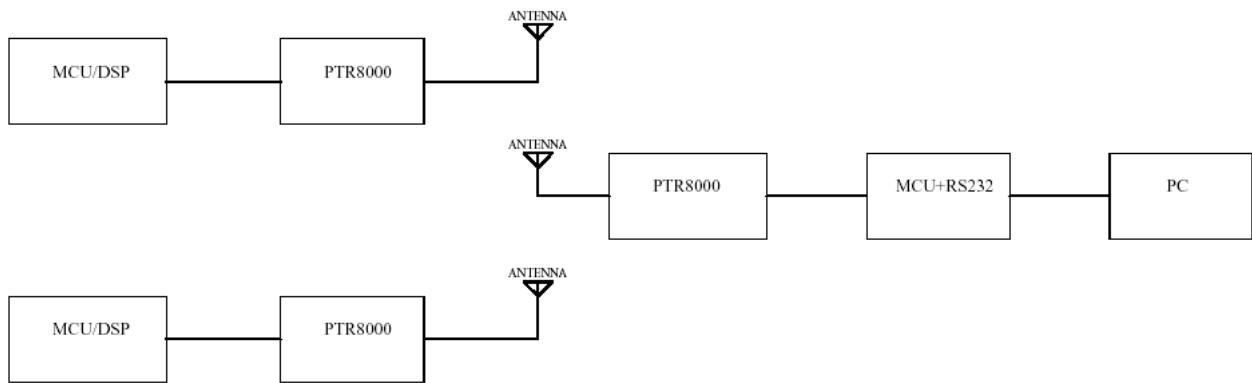

ATTENTION!

Electrostatic sensitive device
Observe precaution for handling.

XUNTONG Technology
www.freqchina.com